

SBD - low profile centrifugal



SBD Series

The SBD series is a low profile high performance centrifugal fan designed for use in ducted ventilation systems. Ideal for commercial, residential and apartment ventilation where cavity space is limited. **All fans include integrated non return dampers as standard.**

Construction

The range is fitted with backward curved centrifugal impellers driven by external rotor motors with sealed for life bearings. Cases are made from injection moulded polymer.

Features

- Wide range of speed control options.
- Non return dampers built in.
- Long spigots for easy duct connection.
- Fits into tight spaces.
- Fans can be mounted at any angle

Testing

Rated fan performance has been determined by testing to ISO 5801 : 2007 . Fan sound data has been determined by testing to ISO 13347 : 2004.

Wiring

Fans are fitted with flex leads and plugs.

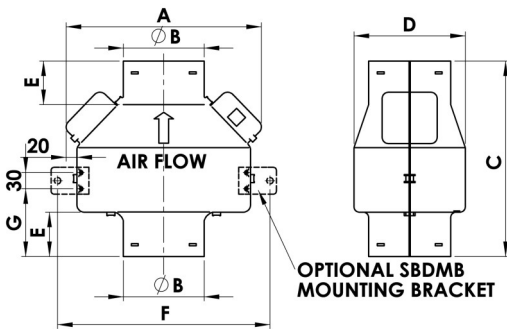

Fan Model	A	∅B	C	D	E	F	G	kg
All 150 models	358	150	350	205	7.5	404	140	3
All 200 models	390	200	385	255	8.3	426	146	4

Fan Model	Full Load Current	Motor kW	Shaft Rev s /min	dB(A) @3m	SPL dB referred to 10 ⁻¹² W							
					63	125	250	500	1K	2K	4K	8K
SBD150-A3-LOW	0.18	0.04	1510	28	55	46	43	42	43	45	31	16
SBD150-A3-MED	0.19	0.042	2130	36	59	50	51	50	51	53	39	34
SBD150-A3-HIGH	0.23	0.052	2560	43	66	59	56	59	58	58	55	45
SBD150-A	0.23	0.052	2350	41	64	57	54	57	56	56	53	43
SBD150-A-SC	0.23	0.052	2350	41	64	57	54	57	56	56	53	43
SBD200-A3-LOW	0.18	0.04	1510	29	56	47	44	43	44	46	32	17
SBD200-A3-MED	0.19	0.042	2130	37	60	51	52	51	52	54	40	35
SBD200-A3-HIGH	0.23	0.052	2560	44	67	60	57	60	59	59	56	46
SBD200-A	0.23	0.052	2350	41	65	66	61	58	57	55	50	46
SBD200-A-SC	0.23	0.052	2350	41	65	66	61	58	57	55	50	46
SBD200-B3-LOW	0.37	0.085	1490	25	55	49	46	43	42	37	31	20
SBD200-B3-MED	0.38	0.086	2022	32	59	54	51	49	49	44	38	32
SBD200-B3-HIGH	0.41	0.091	2605	48	69	63	60	63	65	63	59	55
SBD200-B	0.39	0.088	2100	42	55	61	61	60	58	57	51	47
SBD200-B-SC	0.39	0.088	2100	42	55	61	61	60	58	57	51	47
SBD200-C	0.68	0.155	2500	46	67	61	58	61	63	61	57	53
SBD200-C-SC	0.68	0.155	2500	46	67	61	58	61	63	61	57	53

SBD - low profile centrifugal

Ancillaries

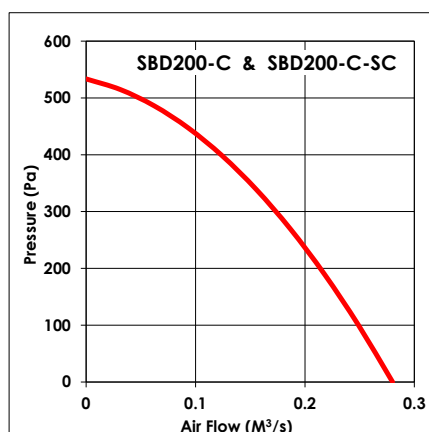
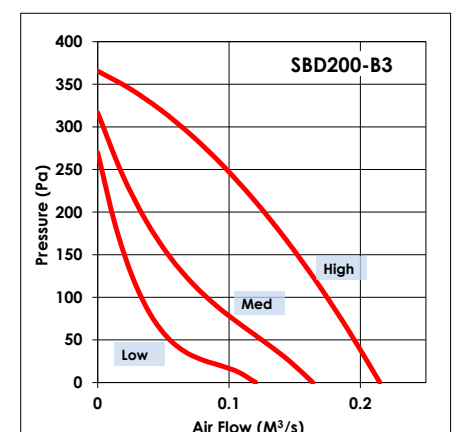
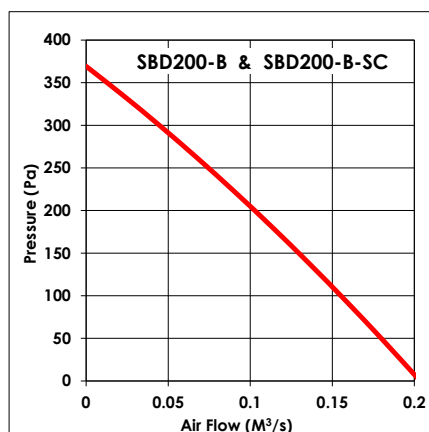
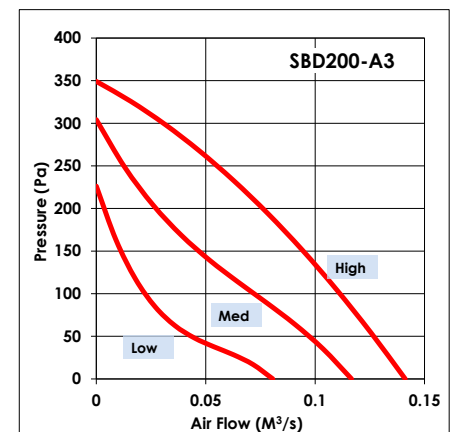
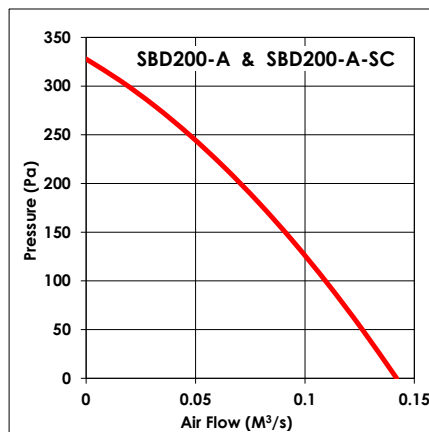
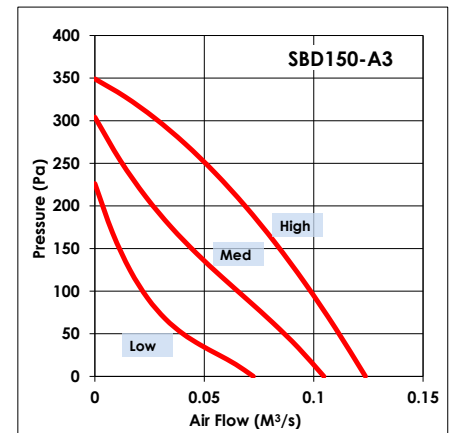
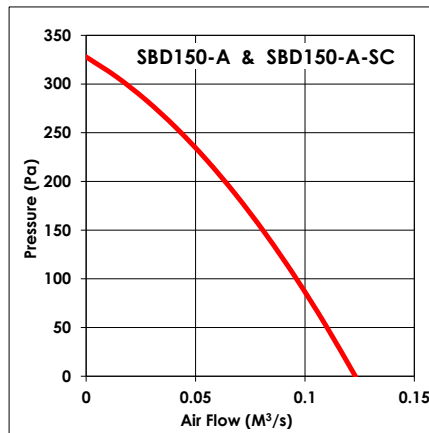

Suggested Specification
 Low profile centrifugal type fans shall be of the SBD Series manufactured by Pacific HVAC Engineering. Backward curved impellers shall be driven by external rotor motors with sealed for life bearings. The fans shall incorporate low resistance back-draft dampers fitted within the outlet spigot. All fans shall be fully tested in accordance with the requirements of ISO 5801 : 2007 for air flow and ISO 13347 : 2004 for sound.